

Robert Bosch Power Tools GmbH
70538 Stuttgart
GERMANY

www.bosch-pt.com

1 609 92A 485 (2017.11) AS / 13



1 609 92A 485

GWS 660 Professional



cn 正本使用说明书



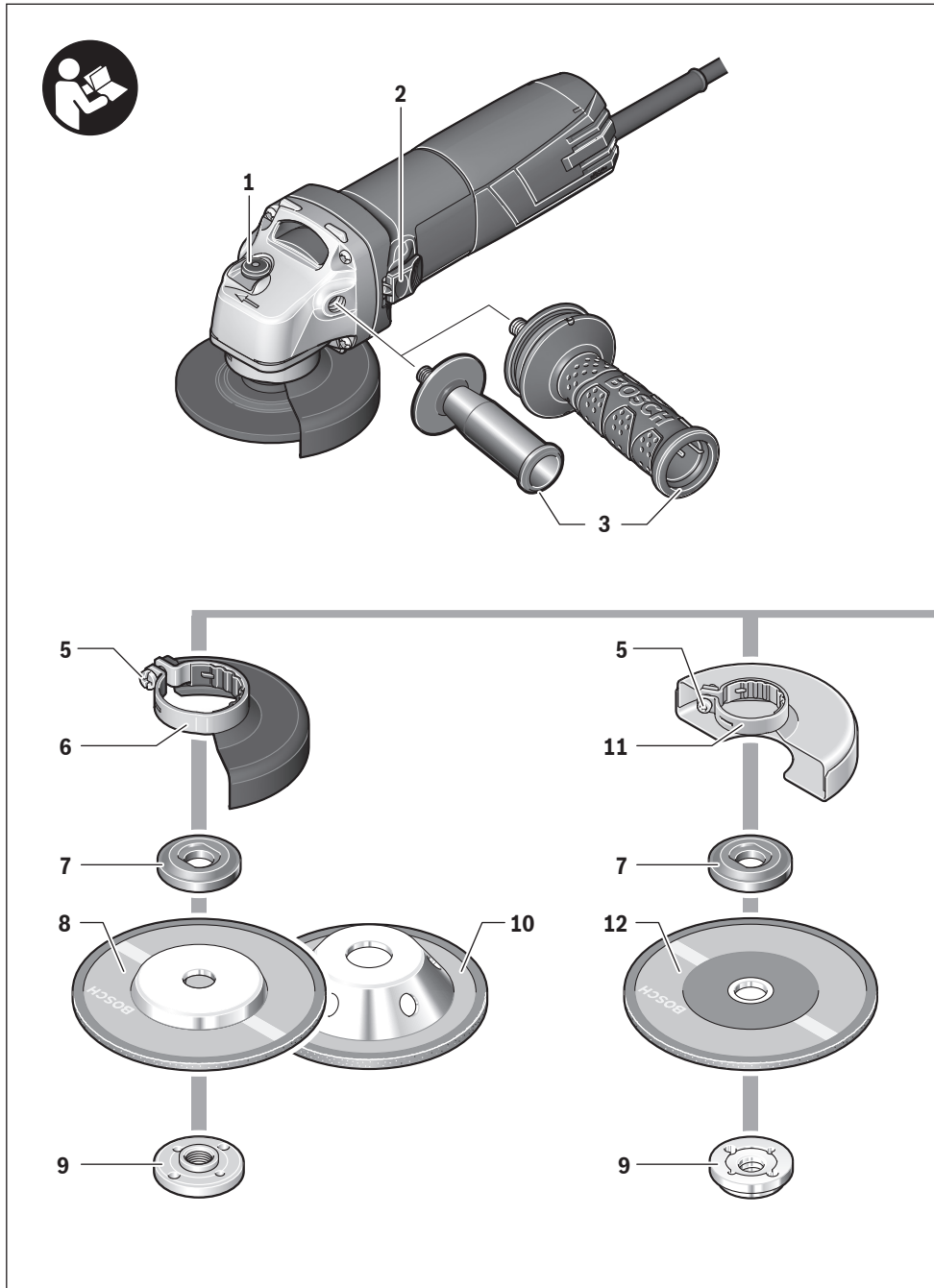

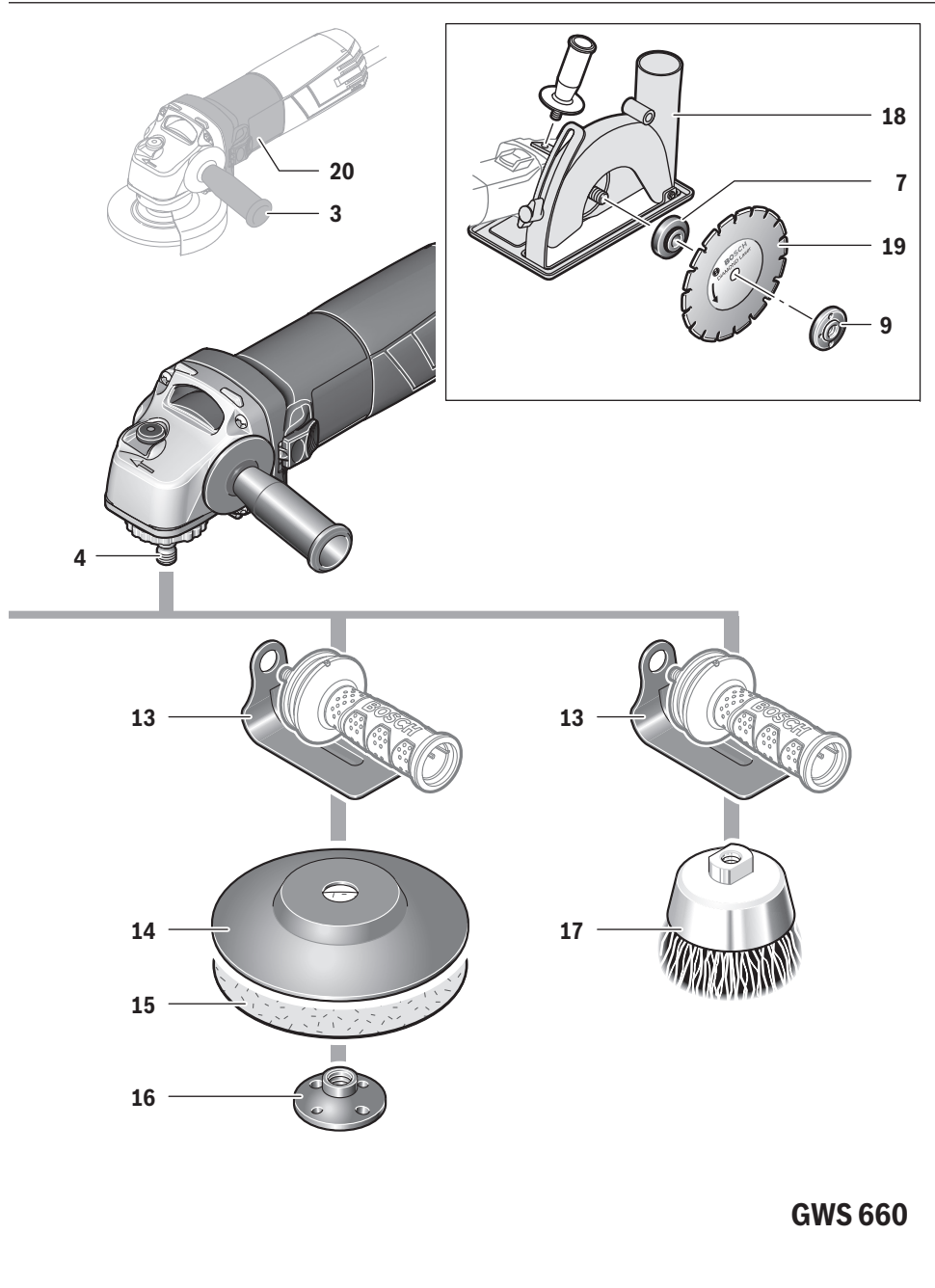

4 | 中文

中文

安全规章

电动工具通用安全警告

警告！ 阅读所有警告和所有说明！不遵照以下警告和说明会导致电击、着火和/或严重伤害。

保存所有警告和说明书以备查阅。

在所有下列的警告中术语“电动工具”指市电驱动（有线）电动工具或电池驱动（无线）电动工具。

工作场地的安全

- ▶ 保持工作场地清洁和明亮。混乱和黑暗的场地会引发事故。
- ▶ 不要在易爆环境，如有易燃液体、气体或粉尘的环境下操作电动工具。电动工具产生的火花会点燃粉尘或气体。
- ▶ 让儿童和旁观者离开后操作电动工具。注意力不集中会使操作者失去对工具的控制。

电气安全

- ▶ 电动工具插头必须与插座相配。绝不能以任何方式改装插头。需接地的电动工具不能使用任何转换插头。未经改装的插头和相配的插座将减少电击危险。
- ▶ 避免人体接触接地表面，如管道、散热片和冰箱。如果你身体接地会增加电击危险。
- ▶ 不得将电动工具暴露在雨中或潮湿环境中。水进入电动工具将增加电击危险。
- ▶ 不得滥用电线。绝不能用电线搬运、拉动电动工具或拔出其插头。使电线远离热源、油、锐边或运动部件。受损或缠绕的软线会增加电击危险。
- ▶ 当在户外使用电动工具时，使用适合户外使用的外接软线。适合户外使用的软线将减少电击危险。
- ▶ 如果在潮湿环境下操作电动工具是不可避免的，应使用剩余电流动作保护器（RCD）。使用RCD可减少电击危险。

人身安全

- ▶ 保持警觉，当操作电动工具时关注所从事的操作并保持清醒。当你感到疲倦，或在有药物、酒精或治疗反应时，不要操作电动工具。在操作电动工具时瞬间的疏忽会导致严重人身伤害。
- ▶ 使用个人防护装置。始终佩戴护目镜。安全装置，诸如适当条件下使用防尘面具、防滑安全鞋、安全帽、听力防护等装置能减少人身伤害。
- ▶ 防止意外启动。确保开关在连接电源和/或电池盒、拿起或搬运工具时处于关断位置。手指放在已接通电源的开关上或开关处于接通时插入插头可能会导致危险。

- ▶ 在电动工具接通之前，拿掉所有调节钥匙或扳手。遗留在电动工具旋转零件上的扳手或钥匙会导致人身伤害。
- ▶ 手不要伸展得太长。时刻注意立足点和身体平衡。这样在意外情况下能很好地控制电动工具。
- ▶ 着装适当。不要穿宽松衣服或佩戴饰品。让衣服、手套和头发远离运动部件。宽松衣服、佩饰或长发可能会卷入运动部件中。
- ▶ 如果提供了与排屑、集尘设备连接用的装置，要确保他们连接完好且使用得当。使用这些装置可减少尘屑引起的危险。

电动工具使用和注意事项

- ▶ 不要滥用电动工具，根据用途使用适当的电动工具。选用适当设计的电动工具会使你工作更有效、更安全。
- ▶ 如果开关不能接通或关断工具电源，则不能使用该电动工具。不能用开关来控制的电动工具是危险的且必须进行修理。
- ▶ 在进行任何调节、更换附件或贮存电动工具之前，必须从电源上拔掉插头和/或使电池盒与工具脱开。这种防护性措施将减少工具意外起动的危险。
- ▶ 将闲置不用的电动工具贮存在儿童所及范围之外，并且不要让不熟悉电动工具或对这些说明不了解的人操作电动工具。电动工具在未经培训的用户手中是危险的。
- ▶ 保养电动工具。检查运动件是否调整到位或卡住，检查零件破损情况和影响电动工具运行的其他状况。如有损坏，电动工具应在使用前修理好。许多事故由维护不良的电动工具引发。
- ▶ 保持切削刀具锋利和清洁。保养良好的有锋利切削刃的刀具不易卡住而且容易控制。
- ▶ 按照使用说明书，考虑作业条件和进行的作业来使用电动工具、附件和工具的刀头等。将电动工具用于那些与其用途不符的操作可能会导致危险。

维修

- ▶ 将你的电动工具送交专业维修人员，使用同样的备件进行修理。这样将确保所维修的电动工具的安全性。

针对角磨机的安全规章

砂磨、砂光、钢丝砂光或砂磨切割操作的通用安全警告

- ▶ 该电动工具是实现砂轮机、砂光机、钢丝刷或切断工具功能的。阅读随该电动工具提供的所有安全警告、说明、图解和规定。不了解以下所列所有说明将导致电击、着火和/或严重伤害。
- ▶ 不推荐用该电动工具进行抛光。电动工具不按指定的功能去操作，可能发生危险和引起人身伤害。

- ▶ 不使用非工具制造商推荐和专门设计的附件。否则该附件可能被装到你的电动工具上，而它不能保证安全操作。
- ▶ 附件的额定速度必须至少等于电动工具上标出的最大速度。附件以比其额定速度大的速度运转会发生爆裂和飞溅。
- ▶ 附件的外径和厚度必须在电动工具额定能力范围之内。不正确的附件尺寸不能得到充分防护或控制。
- ▶ 砂轮、法兰盘、靠背垫或任何其他附近的轴孔尺寸必须适合于安装到电动工具的主轴上。带轴孔的、与电动工具安装件不配的附件将会失稳、过度振动并会引起失控。
- ▶ 不要使用损坏的附件。在每次使用前要检查附件，例如砂轮是否有碎片和裂缝，靠背垫是否有裂缝，撕裂或过度磨损，钢丝刷是否松动或金属丝是否断裂。如果电动工具或附件跌落了，检查是否有损坏或安装没有损坏的附件。检查和安装附件后，让自己和旁观者的位置远离旋转附件的平面，并以电动工具最大空载速度运行 1 分钟。损坏的附件通常在该试验时会碎裂。
- ▶ 戴上防护用品。根据适用情况，使用面罩，安全护目镜或安全眼镜。适用时，戴上防尘面具，听力保护器，手套和能挡小磨料或工件碎片的工作围裙。眼防护罩必须挡住各种操作产生的飞屑。防尘面具或口罩必须能够过滤操作产生的颗粒。长期暴露在高强度噪音中会引起失聪。
- ▶ 让旁观者与工作区域保持一安全距离。任何进入工作区域的人必须戴上防护用品。工件或破损附件的碎片可能会飞出并引起紧靠着操作区域的旁观者的伤害。切割附件触及带电导线会使电动工具外露的金属零件带电，并使操作者触电。
- ▶ 当在切割附件有可能切割到暗线或自身电线的场所进行操作时，只能通过绝缘握持面来握住电动工具。切割附件碰到一根带电导线可能会使电动工具外露的金属零件带电并使操作者发生电击危险。
- ▶ 使软线远离旋转的附件。如果控制不当，软线可能被切断或缠绕，并使得你的手或手臂可能被卷入旋转附件中。
- ▶ 直到附件完全停止运动才放下电动工具。并且不得使用任何外力迫使金刚石切割片停转。旋转的附件可能会抓住表面并拉动电动工具而让你失去对工具的控制。
- ▶ 当携带电动工具时不要开动它。意外地触及旋转附件可能会缠绕你的衣服而使附件伤害身体。
- ▶ 经常清理电动工具的通风口。电动机风扇会将灰尘吸进机壳，过多的金属粉末沉积会导致电气危险。
- ▶ 不要在易燃材料附近操作电动工具。火星可能会点燃这些材料。
- ▶ 不要使用需用冷却液的附件。用水或其他冷却液可能导致电腐蚀或电击。

反弹和相关警告

- ▶ 反弹是因卡住或缠绕住的旋转砂轮，靠背垫，钢丝刷或其他附件而产生的突然反作用力。卡住或缠绕会引起旋转附件的迅速堵转，随之使失控的电动工具在卡住点产生与附件旋转方向相反的运动。例如，如果砂轮被工件缠绕或卡住了，伸入卡住点的砂轮边缘可能会进入材料表面而引起砂轮爬出或反弹。砂轮可能飞向或飞离操作者，这取决于砂轮在卡住点的运动方向。在此条件下砂轮也可能碎裂。
- ▶ 反弹是电动工具误用和 / 或不正确操作工序或条件的结果。可以通过采取以下给出的适当预防措施得以避免。
- ▶ 保持紧握电动工具，使你的身体和手臂处于正确状态以抵抗反弹力。如有辅助手柄，则要一直使用，以便最大限度控制住启动时的反弹力或反力矩。如采取合适的预防措施，操作者就可以控制反力矩或反弹力。
- ▶ 绝不能将手靠近旋转附件。附件可能会反弹碰到手。
- ▶ 不要站在发生反弹时电动工具可能移动到的地方。反弹将在缠绕点驱使工具逆砂轮运动方向运动。
- ▶ 当在尖角、锐边等处作业时要特别小心。避免附件的弹跳和缠绕。尖角、锐边和弹跳具有缠绕旋转附件的趋势并引起反弹的失控。
- ▶ 不要安装上锯链、木雕刀片或带齿锯片。这些锯片会产生频繁的反弹和失控。

对磨削和砂磨切割操作的专用安全警告

- ▶ 只使用所推荐的砂轮型号和为选用砂轮专门设计的护罩。不是为电动工具设计的砂轮不能充分得到防护，是不安全的。
- ▶ 安装弯曲的砂轮时，砂轮的研磨面不可以突出于防护罩缘之外。防护罩无法遮蔽因为安装不当而突出于防护罩缘之外的砂轮。
- ▶ 防护必须牢固地装在电动工具上，且放置得最具安全性，只有最小的砂轮部分暴露在操作人面前。护罩帮助操作者免于受到爆裂砂轮片和偶然触及砂轮的危险。
- ▶ 砂轮只用作推荐的用途。例如：不要用切割砂轮的侧面进行磨削。施加到砂轮侧面的力可能会使其碎裂。
- ▶ 始终为所选砂轮选用未损坏的，有恰当规格和形状的砂轮法兰盘。合适的砂轮法兰盘支承砂轮可以减少砂轮破裂的可能性。切割砂轮的法兰盘可以不同于砂轮法兰盘。
- ▶ 不要使用从大规格电动工具上用剩的磨损砂轮。用于大规格电动工具上的砂轮不适用于较小规格工具的高速工况并可能会爆裂。

6 | 中文

对砂轮切割操作的附加专用安全警告

- ▶ 不要“夹”住切割砂轮或施加过大的压力。不要试图做过深的切割。给砂轮施加过应力增加了砂轮在切割时的负载，容易缠绕或卡住，增加了反弹或砂轮爆裂的可能性。
- ▶ 身体不要对着旋转砂轮，也不要站在其后。当把砂轮从操作者身边的操作点移开时，可能的反弹会使旋转砂轮和电动工具朝你推来。
- ▶ 当砂轮被卡住或无论任何原因而中断切割时，关掉电动工具并握住工具不要动，直到砂轮完全停止。决不要试图当砂轮仍然运转时使切割砂轮脱离切割，否则会发生反弹。调查并采取校正措施以消除砂轮卡住的原因。
- ▶ 不能在工件上重新启动切割操作。让砂轮达到全速后再小心地重新进入切割。如果电动工具在工件上重新启动，砂轮可能会卡住、爬出或反弹。
- ▶ 支撑住板材或超大工件可使得砂轮卡住和反弹的危险降到最低限度。大工件凭借自重而下垂。必须在工件靠近切割线处和砂轮两侧近工件边缘处放置支承。
- ▶ 当进行“盲切割”进入墙体或其他盲区时要格外小心。伸出的砂轮可能会割到煤气管或水管，电线或由此引起反弹的物体。

砂光操作的专用安全警告

- ▶ 当砂光时，不要使用超大砂盘纸。选用砂盘纸时应按照制造商的推荐。超出砂光垫盘的大砂盘纸有撕裂的危险并且会引起缠绕、砂盘的撕裂或反弹。

钢丝刷操作的专用安全警告

- ▶ 要意识到即使正常操作时钢丝线也会从刷子甩出。不要对钢丝刷施加过大的负荷而使得钢丝线承受过应力。钢丝线可能会轻易刺入薄的衣服和 / 或皮肤内。
- ▶ 如果建议钢丝刷使用护罩，则不允许该护罩对钢丝轮或钢丝刷有任何干扰。钢丝轮或钢丝刷在工作负荷和离心力作用下直径会变大。

其它的警告事项

请佩戴护目镜。

- ▶ 使用合适的侦测装置侦察隐藏的电线，或者向当地的相关单位寻求支援。接触电线可能引起火灾并让操作者触电。损坏了瓦斯管会引起爆炸。凿穿水管不仅会造成严重的财物损失，也可能导致触电。
- ▶ 如果电源突然中断，例如停电或不小心拔出插头，得马上解除起停开关的锁定并把它设定在关闭的位置。这样可以避免机器突然起动。

- ▶ 在研磨 / 割片尚未冷却之前，切勿紧握研磨 / 割片。工作时切割片会变得非常炙热。
- ▶ 固定好工件。使用固定装置或老虎钳固定工件，会比手持握工件更牢固。

产品和功率描述

阅读所有的警告提示和指示。如未确实遵循警告提示和指示，可能导致电击，火灾并且 / 或其他的严重伤害。

按照规定使用机器

本电动工具适合在金属和石材上进行切割，粗磨以及使用钢丝刷研磨。
操作机器时不需要用水冲刷。
使用结合的磨具切割时，必须安装特殊的切割防护罩。
切割石材时，必须安装合适的吸尘装置。
安装了经过许可的磨具后，也可以使用本电动工具进行砂纸研磨。

插图上的机件

机件的编号和电动工具详解图上的编号一致。

- 1 主轴锁定键
- 2 起停开关
- 3 辅助手柄（绝缘握柄）*
- 4 主轴
- 5 防护罩的固定螺丝
- 6 针对研磨时使用的防护罩
- 7 接头法兰
- 8 磨片*
- 9 夹紧螺母
- 10 超合金杯碟*
- 11 针对切割时使用的防护罩*
- 12 切割片*
- 13 护手片*
- 14 橡胶磨盘*
- 15 砂纸*
- 16 圆螺母*
- 17 杯形钢丝刷*
- 18 以导引板切割时所使用的吸尘罩*
- 19 金刚石切割片*
- 20 手柄（绝缘握柄）

*图或说明上提到的附件，并不包含在基本的供货范围内。本公司的附件清单中有完整的附件供应项目。

技术数据

角磨机		GWS 660
物品代码		3 601 C75 6..
额定输入功率	瓦	660
额定转速	次 / 分	11000
最大砂轮直径	毫米	100
主轴螺纹		M 10
研磨轴上的最大螺纹长度	毫米	17
重量符合 EPTA-Procedure 01:2014	公斤	1,6
重量 (净重) *	公斤	1,5
绝缘等级		□/II

* 测量时不含防护罩和辅助手柄
本说明书提供的参数是以 230 V 为依据，于低电压地区，此数据有可能不同。

安装**安装保护装备**

- ▶ **维修电动工具或换装零、配件之前，务必从插座上拔出插头。**

指示：如果研磨片在工作中途断裂了，或者防护罩上 / 电动工具上的接头损坏了，务必即刻将电动工具交给顾客服务处修理。地址可以参考“顾客服务处和顾客咨询中心”。

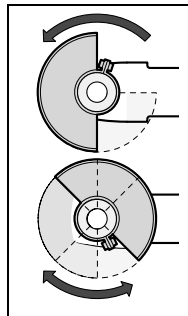
研磨时使用的防护罩

把防护罩 6 安装到主轴上。根据工作需要调整好防护罩 6 的位置。接着再使用固定螺丝 5 锁定防护罩 6。

- ▶ **适度地调整防护罩 6，避免让工作时产生的火花喷向操作者。**

指示：防护罩 6 上有特殊突起，如此可以避免在电动工具上安装了不合适的防护罩。

切割时使用的防护罩

- ▶ **使用结合的磨具切割时，务必安装针对切割的防护罩 11。**
- ▶ **在石材上进行切割时，必须安装合适的吸尘装置。**

以安装研磨防护罩 6 的方式安装切割防护罩 11。

切割时使用的带有导引板的吸尘罩

以安装研磨防护罩 6 的方式安装切割时使用的带有导引板的吸尘罩 18。

辅助手柄

根据工作要求，把辅助手柄 3 安装在机头的右侧或左侧。

护手片

- ▶ **使用橡胶磨盘 14，杯形钢丝刷，轮刷和千叶砂磨轮工作时，务必在机器上加装护手片 13。**

使用辅助手柄 3 夹住护手片 13。

安装磨具

- ▶ **维修电动工具或换装零、配件之前，务必从插座上拔出插头。**

- ▶ 在研磨 / 割片尚未冷却之前，切勿紧握研磨 / 割片。工作时切割片会变得非常炙热。

清洁主轴 4 和所有即将安装的零件。

安装及拆卸磨具时，必须先使用主轴锁定键 1 固定主轴。

- ▶ 待主轴完全静止后，才可以使用主轴锁定键。否则可能会损坏电动工具。

研磨 / 切割片

注意磨具的规格。磨具上的孔直径必须和固定法兰完全吻合。不可以使用转接头或异径管。

使用金刚石切割片时，金刚石切割片上的箭头方向，必须和机器的转向一致（参考机头上的转向箭头）。

安装过程请参考插图。

固定研磨 / 切割片时，先拧上夹紧螺母 9 接着再使用双销扳手拧紧螺母。

- ▶ **在安装好磨具且尚未开动机器之前，必须检查磨具是否正确地装牢了，磨具能否自由无阻地旋转。务必确定磨具转动时不会和防护罩或其它的机件产生摩擦。**

针对 M 10 主轴的固定法兰：这个固定法兰是双面都可以使用的。

千叶砂磨轮

- ▶ **使用千叶砂磨轮工作时务必在机器上加装护手片 13。**

橡胶磨盘

- ▶ **使用橡胶磨盘 14 工作时务必在机器上加装护手片 13。**

安装过程请参考插图。

转入圆螺母 16 并使用双销扳手拧紧。

8 | 中文

杯形钢丝刷 / 轮刷

- ▶ **使用杯形钢丝刷或轮刷工作时务必在机器上加装护手片 13。**

安装过程请参考插图。



把杯形钢丝刷 / 轮刷装入主轴中，上述磨具必须紧靠
在主轴螺纹末端的法兰上。使用开口扳手拧紧杯形钢
丝刷 / 轮刷装。

机器适用的磨具

您可以使用本说明书中提到的所有磨具。

选用磨具的许可转速（次 / 分）或圆周转速
（米 / 秒），必须和以下表格中的数据一致。

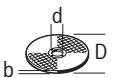
因此必须认清磨具标签上的许可 转速 / 圆周速度。

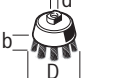
	最大		D	b	d	[次 / 分]	[米 / 秒]
	[毫米]	[毫米]					
	100	6	16,0	11000	80		
	100	-	-	11000	80		
	70	30	M 10	11000	45		

旋转机头

- ▶ **维修电动工具或换装零、配件之前，务必从插座上拔出插头。**

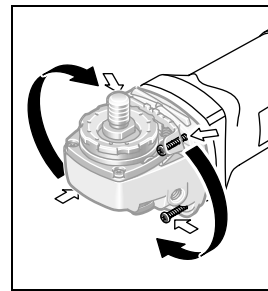

机器操作者可根据需要分段式转动机头，每一段的旋转角度为 90 度。此功能的优点是能够在特殊的工作状况下，把起停开关移动到比较容易操作的位置，例如针对左撇子。

先转出 4 个螺丝。小心地把机头旋转到需要的位置上，无须从

机壳上拆下机头。装回 4 个螺丝并将其拧紧。

吸锯尘 / 吸锯屑

- ▶ 含铅的颜料以及某些木材、矿物和金属的加工废尘有害健康。机器操作者或者工地附近的人如果接触、吸入这些废尘，可能会有过敏反应或者感染呼吸道疾病。

某些尘埃（例如加工橡木或山毛榉的废尘）可能致癌，特别是和处理木材的添加剂（例如木材的防腐剂等）结合之后。只有经过专业训练的人才能够加工含石棉的物料。

- 尽可能使用适合物料的吸尘装置。
- 工作场所要保持空气流通。
- 最好佩戴 P2 滤网等级的口罩。

请留心并遵守贵国和加工物料有关的法规。

- ▶ 避免让工作场所堆积过多的尘垢。尘埃容易被点燃。

操作**操作机器**

- ▶ **注意电源的电压！电源的电压必须和电动工具铭牌上标示的电压一致。**

- ▶ 机器上的附件可能割断隐藏着的电线或机器本身的电源线，所以一定要握着绝缘手柄 20 和辅助手柄 3 操作机器。电动工具的附件如果接触了带电的线路，机器上的金属零件会导电，可能造成操作者触电。

如果把电动工具连接在行动的发电装置上（例如发电机），由于上述装置的备用功率不足，而且也没有合适的电压调节器（例如未配备启动电流加强装置），可能在开动机器时发生功率不足或其它不寻常的反应。

操作机器时必须把机器连接在合适的电源上，并且要使用正确的电压和电频率。

开动 / 关闭

为了节约能源，只在当您使用机器时，才开动电动工具。

开动电动工具时，必须向前推移起停开关 2。

按下起停开关 2 的前端并让开关卡在这个位置，便可以固定起停开关 2。

放开起停开关 2 即可关闭电动工具。如果开关被固定了，可以先按下起停开关 2 的后端并随即放开。

- ▶ 开机前，先检查是否已经正确地安装好磨具，观察磨具转动时会不会产生磨擦，并且要进行至少 1 分钟的无负载试机。切勿使用损坏、变形或转动时会震动的磨具。损坏的磨具可能断裂并造成伤害。

有关操作方式的指点

- ▶ **在支撑墙上开缝时必须特别小心，参考 "有关静力学的注意事项"。**
- ▶ **固定好站立不稳的工件。**
- ▶ **勿让电动工具因为过载而停止转动。**
- ▶ **强烈过载之后必须让电动工具在无载的状况下运转数分钟，这样能够帮助电动工具冷却。**

- ▶ 在研磨/割片尚未冷却之前，切勿持握研磨/割片。工作时切割片会变得非常炙热。
- ▶ 不可以把电动工具安装在切割研磨架上操作。
- ▶ 机器上的附件可能割断隐藏着的电线或机器本身的电源线，所以一定要握着绝缘手柄 20 和辅助手柄 3 操作机器。电动工具的附件如果接触了带电的线路，机器上的金属零件会导电，可能造成操作者触电。

粗磨

- ▶ 勿使用切割片进行粗磨作业。

粗磨时如果砂轮和研磨表面成 30 或 40 度角，则能够达到最好的粗磨效果。操作时只须轻压并来回地移动机器，如此加工物料才不会变热，不会变色，并且物件表面不会出现凹陷的痕迹。

千叶砂磨轮

使用千叶砂磨轮（附件）可以在隆起的表面和型材上研磨。

千叶砂磨轮的使用寿命，会比一般砂轮的使用寿命长。而且它的工作噪音和研磨温度也比较低。

切割金属

- ▶ 使用结合的磨具切割时，务必安装针对切割的防护罩 11。

切割时必须施力均匀，得根据工件的物料来决定推动的力道。操作机器时勿重压机器，勿倾斜，勿摇晃。

不可以使用侧压的方式来制止仍继续转动的切割片。

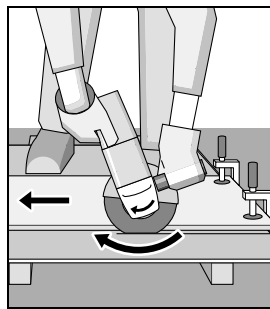

必须逆著机器的转向推动电动工具，否则容易失控，并导致电动工具从切线中滑出。

切割型材和四角钢管时，必须从直径最小处开始切割。

切割石材

- ▶ 在石材上进行切割时，必须安装合适的吸尘装置。
- ▶ 请佩戴防尘面具。
- ▶ 本电动工具只能进行乾式切割和乾式研磨。

切割石材时最好使用金刚石切割片。

使用带有导引板的吸尘罩 18 切割时，必须使用检验合格的石尘专用吸尘装置。博世提供了合适的吸尘器。

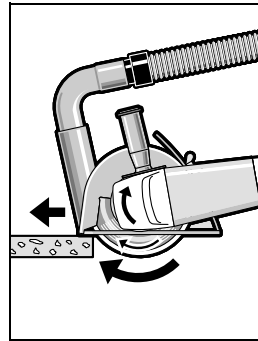

开动电动工具，并把导引装置的前端放置在工件上。参考工件的物料，适当地施力推进机器。

切割高硬度的工件时，例如碎石含量很高的水泥，可能因为金刚石切割片过热而导致切割片损坏。如果切割工件过硬，操作机器时金刚石切割片的周围会出现火花。

此时必须停下工作。

让切割片在空载的状况下以最高转速运作片刻，如此可以帮助降低切割片的温度。

如果切割片的切割效率明显降低，而且进行切割时会出现火花环，则表示金刚石切割片已经变钝。如果发生上述状况，可以把切割片在研磨材料上（例如石灰砂石）来回刷磨数次，这样切割片又会锋利如初。

有关静力学的注意事项

关于在支撑墙上开缝时应该注意的事项，请参考 DIN 1053 第一部的规定，或各国有关的法规。务必确实遵循相关的法令规定。正式动工以前，先向负责的静力学者，工程师或工程负责人请教有关细节。

维修和服务

维修和清洁

- ▶ 维修电动工具或换装零、配件之前，务必从插座上拔出插头。
- ▶ 电动工具和通风间隙都必须保持清洁，这样才能够提高工作品质和安全性。
- ▶ 在某些极端的操作环境下，如果可能的话一定要使用吸尘装备。吹除通气孔中的污垢并且要使用故障电流保护开关（PRCD）。加工金属时可能在电动工具的内部堆积会导电的废尘。这样可能会影响电动工具的安全绝缘性能。

小心地保存和使用附件。

如果必须更换连接线，务必把这项工作交给博世或者经授权的博世电动工具顾客服务执行，以避免危害机器的安全性能。

顾客服务处和顾客咨询中心

本公司顾客服务处负责回答有关本公司产品的修理、维护和备件的问题。以下的网页中有爆炸图和备件的资料：

www.bosch-pt.com

博世顾客咨询团队非常乐意为您解答有关公司产品及附件的问题。

10 | 中文

询问和订购备件时，务必提供机器铭牌上标示的
10 位数物品代码。

有关保证，维修或更换零件事宜，请向合格的经销商
查询。

中国大陆

博世电动工具（中国）有限公司

中国 浙江省 杭州市

滨江区滨康路 567 号

邮政编码：310052

免费服务热线：4008268484

传真：(0571) 87774502

电邮：contact.ptcn@cn.bosch.com

www.bosch-pt.com.cn

罗伯特·博世有限公司

香港北角英皇道 625 号 21 楼

客户服务热线：+852 2101 0235

传真：+852 2590 9762

电邮：info@hk.bosch.com

网站：www.bosch-pt.com.hk

制造商地址：

Robert Bosch Power Tools GmbH

罗伯特·博世电动工具有限公司

70538 Stuttgart / GERMANY

70538 斯图加特 / 德国

处理废弃物

必须以符合环保的方式，回收再利用损坏的机器、附
件和废弃的包装材料。

不可以把电动工具丢入家庭垃圾中！

保留修改权。

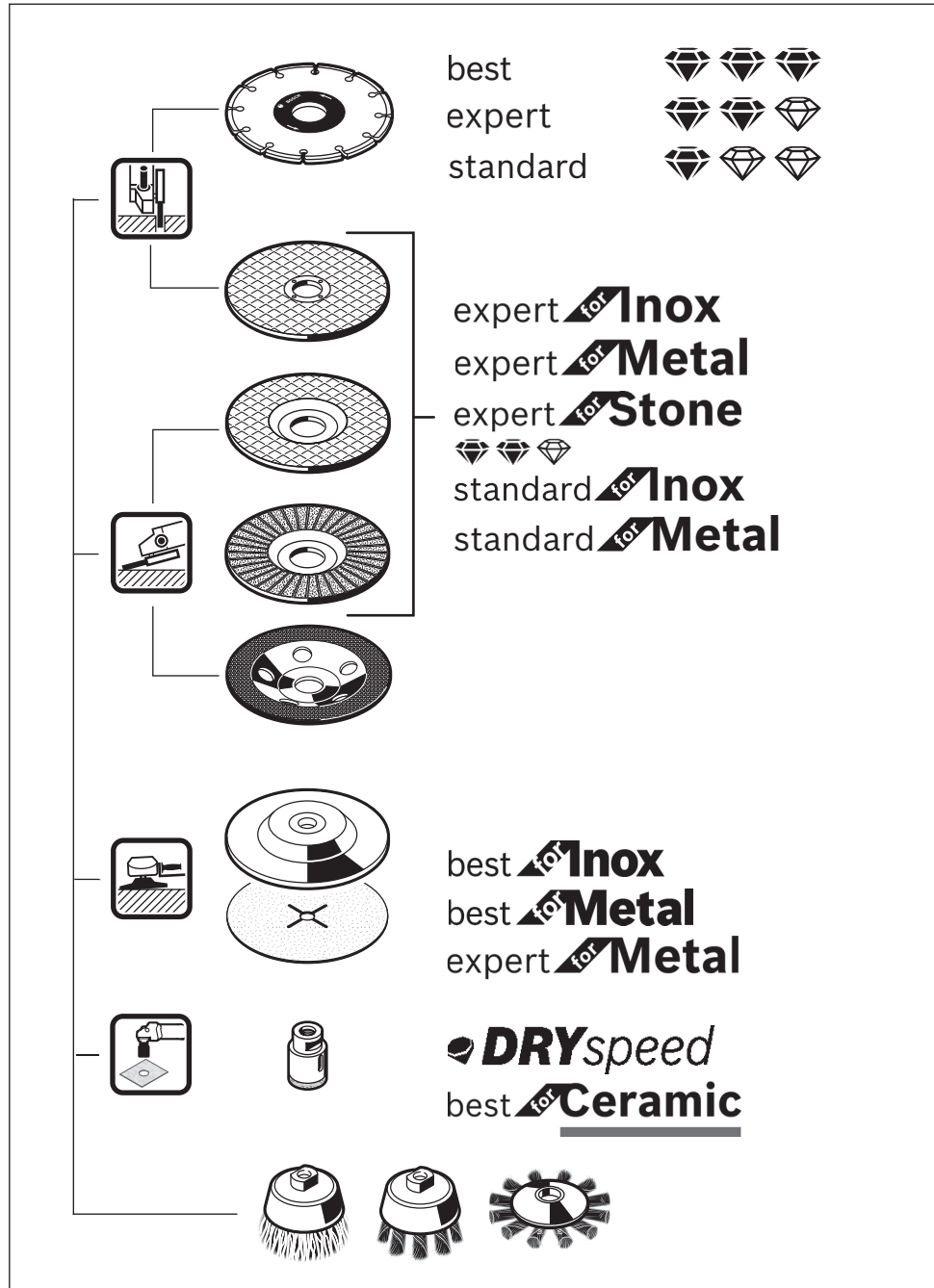

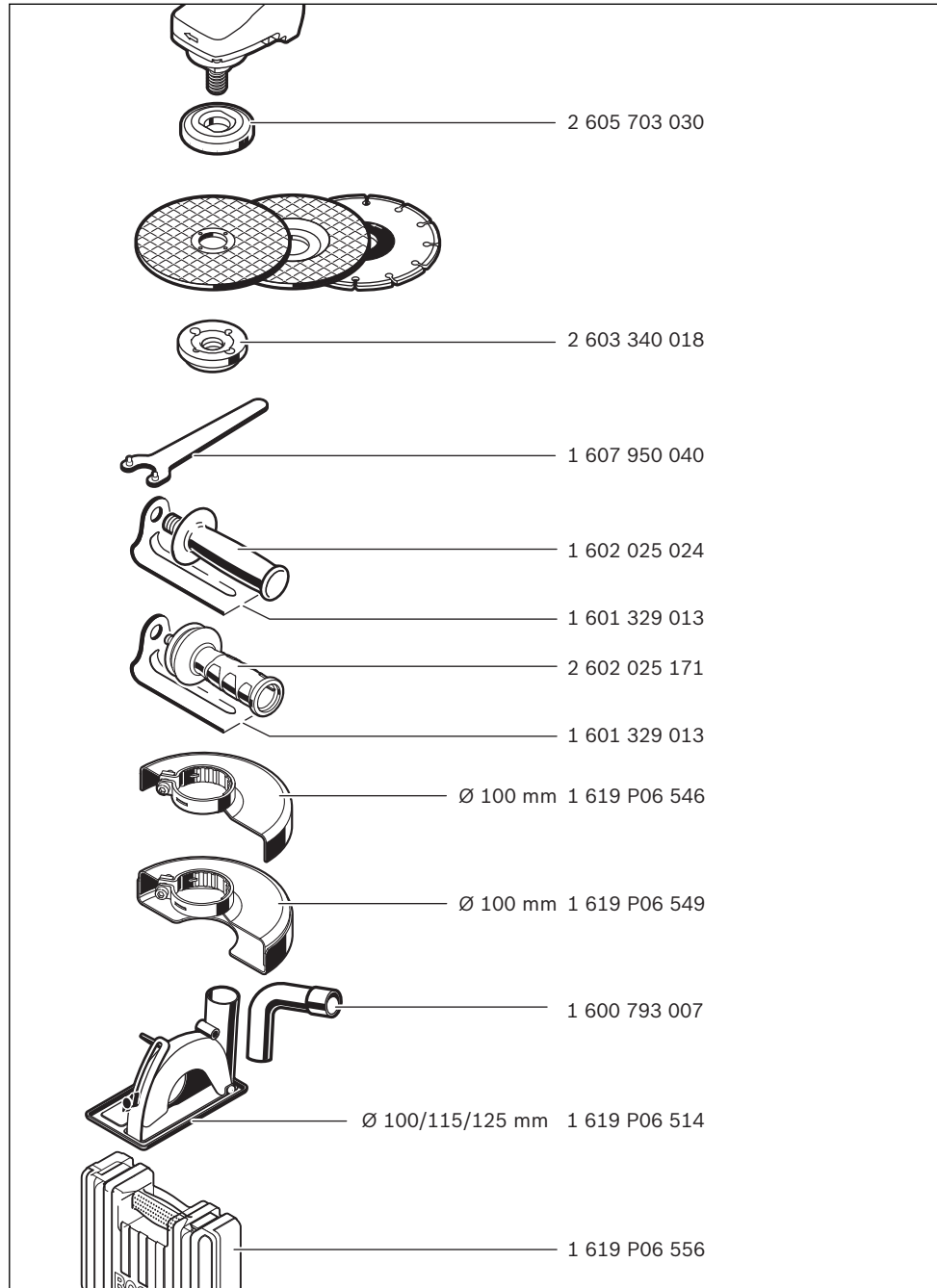

以下各页勿打印！

***Following pages
are NOT for printing!***

English

Safety Notes

General Power Tool Safety Warnings

⚠ WARNING Read all safety warnings and all instructions. Failure to follow the warnings and instructions may result in electric shock, fire and/or serious injury.

Save all warnings and instructions for future reference. The term power tool in the warnings refers to your mains-operated (corded) power tool or battery-operated (cordless) power tool.

Work area safety

- ▶ **Keep work area clean and well lit.** Cluttered or dark areas invite accidents.
- ▶ **Do not operate power tools in explosive atmospheres, such as in the presence of flammable liquids, gases or dust.** Power tools create sparks which may ignite the dust or fumes.
- ▶ **Keep children and bystanders away while operating a power tool.** Distractions can cause you to lose control.

Electrical safety

- ▶ **Power tool plugs must match the outlet. Never modify the plug in any way. Do not use any adapter plugs with earthed (grounded) power tools.** Unmodified plugs and matching outlets will reduce risk of electric shock.
- ▶ **Avoid body contact with earthed or grounded surfaces, such as pipes, radiators, ranges and refrigerators.** There is an increased risk of electric shock if your body is earthed or grounded.
- ▶ **Do not expose power tools to rain or wet conditions.** Water entering a power tool will increase the risk of electric shock.
- ▶ **Do not abuse the cord. Never use the cord for carrying, pulling or unplugging the power tool. Keep cord away from heat, oil, sharp edges and moving parts.** Damaged or entangled cords increase the risk of electric shock.
- ▶ **When operating a power tool outdoors, use an extension cord suitable for outdoor use.** Use of a cord suitable for outdoor use reduces the risk of electric shock.
- ▶ **If operating a power tool in a damp location is unavoidable, use a residual current device (RCD) protected supply.** Use of an RCD reduces the risk of electric shock.

Personal safety

- ▶ **Stay alert, watch what you are doing and use common sense when operating a power tool. Do not use a power tool while you are tired or under the influence of drugs, alcohol or medication.** A moment of inattention while operating power tools may result in serious personal injury.
- ▶ **Use personal protective equipment. Always wear eye protection.** Protective equipment such as dust mask,

non-skid safety shoes, hard hat, or hearing protection used for appropriate conditions will reduce personal injuries.

- ▶ **Prevent unintentional starting. Ensure the switch is in the off-position before connecting to power source and/or battery pack, picking up or carrying the tool.** Carrying power tools with your finger on the switch or energising power tools that have the switch on invites accidents.
- ▶ **Remove any adjusting key or wrench before turning the power tool on.** A wrench or a key left attached to a rotating part of the power tool may result in personal injury.
- ▶ **Do not overreach. Keep proper footing and balance at all times.** This enables better control of the power tool in unexpected situations.
- ▶ **Dress properly. Do not wear loose clothing or jewellery. Keep your hair, clothing and gloves away from moving parts.** Loose clothes, jewellery or long hair can be caught in moving parts.
- ▶ **If devices are provided for the connection of dust extraction and collection facilities, ensure these are connected and properly used.** Use of dust collection can reduce dust-related hazards.

Power tool use and care

- ▶ **Do not force the power tool. Use the correct power tool for your application.** The correct power tool will do the job better and safer at the rate for which it was designed.
- ▶ **Do not use the power tool if the switch does not turn it on and off.** Any power tool that cannot be controlled with the switch is dangerous and must be repaired.
- ▶ **Disconnect the plug from the power source and/or the battery pack from the power tool before making any adjustments, changing accessories, or storing power tools.** Such preventive safety measures reduce the risk of starting the power tool accidentally.
- ▶ **Store idle power tools out of the reach of children and do not allow persons unfamiliar with the power tool or these instructions to operate the power tool.** Power tools are dangerous in the hands of untrained users.
- ▶ **Maintain power tools. Check for misalignment or binding of moving parts, breakage of parts and any other condition that may affect the power tool's operation. If damaged, have the power tool repaired before use.** Many accidents are caused by poorly maintained power tools.
- ▶ **Keep cutting tools sharp and clean.** Properly maintained cutting tools with sharp cutting edges are less likely to bind and are easier to control.
- ▶ **Use the power tool, accessories and tool bits etc. in accordance with these instructions, taking into account the working conditions and the work to be performed.** Use of the power tool for operations different from those intended could result in a hazardous situation.

Service

- ▶ **Have your power tool serviced by a qualified repair person using only identical replacement parts.** This will ensure that the safety of the power tool is maintained.

Safety Warnings for Angle Grinder

Safety Warnings common for Grinding, Sanding, Wire Brushing or Abrasive Cutting Off Operations

- ▶ **This power tool is intended to function as a grinder, sander, wire brush or cut-off tool. Read all safety warnings, instructions, illustrations and specifications provided with this power tool.** Failure to follow all instructions listed below may result in electric shock, fire and/or serious injury.
- ▶ **Operations such as polishing are not recommended to be performed with this power tool.** Operations for which the power tool was not designed may create a hazard and cause personal injury.
- ▶ **Do not use accessories which are not specifically designed and recommended by the tool manufacturer.** Just because the accessory can be attached to your power tool, it does not assure safe operation.
- ▶ **The rated speed of the accessory must be at least equal to the maximum speed marked on the power tool.** Accessories running faster than their rated speed can break and fly apart.
- ▶ **The outside diameter and the thickness of your accessory must be within the capacity rating of your power tool.** Incorrectly sized accessories cannot be adequately guarded or controlled.
- ▶ **Threaded mounting of accessories must match the grinder spindle thread. For accessories mounted by flanges, the arbour hole of the accessory must fit the locating diameter of the flange.** Accessories that do not match the mounting hardware of the power tool will run out of balance, vibrate excessively and may cause loss of control.
- ▶ **Do not use a damaged accessory. Before each use inspect the accessory such as abrasive wheels for chips and cracks, backing pad for cracks, tear or excess wear, wire brush for loose or cracked wires. If power tool or accessory is dropped, inspect for damage or install an undamaged accessory. After inspecting and installing an accessory, position yourself and bystanders away from the plane of the rotating accessory and run the power tool at maximum no-load speed for one minute.** Damaged accessories will normally break apart during this test time.
- ▶ **Wear personal protective equipment. Depending on application, use face shield, safety goggles or safety glasses. As appropriate, wear dust mask, hearing protectors, gloves and shop apron capable of stopping small abrasive or workpiece fragments.** The eye protection must be capable of stopping flying debris generated by various operations. The dust mask or respirator must be capable of filtering particles generated by your operation. Prolonged exposure to high intensity noise may cause hearing loss.
- ▶ **Keep bystanders a safe distance away from work area. Anyone entering the work area must wear personal protective equipment.** Fragments of workpiece or of a broken accessory may fly away and cause injury beyond immediate area of operation.
- ▶ **Hold the power tool by insulated gripping surfaces only, when performing an operation where the cutting accessory may contact hidden wiring or its own cord.** Cutting accessory contacting a "live" wire may make exposed metal parts of the power tool "live" and could give the operator an electric shock.
- ▶ **Position the cord clear of the spinning accessory.** If you lose control, the cord may be cut or snagged and your hand or arm may be pulled into the spinning wheel.
- ▶ **Never lay the power tool down until the accessory has come to a complete stop.** The spinning wheel may grab the surface and pull the power tool out of your control.
- ▶ **Do not run the power tool while carrying it at your side.** Accidental contact with the spinning accessory could snag your clothing, pulling the accessory into your body.
- ▶ **Regularly clean the power tool's air vents.** The motor's fan will draw the dust inside the housing and excessive accumulation of powdered metal may cause electrical hazards.
- ▶ **Do not operate the power tool near flammable materials.** Sparks could ignite these materials.
- ▶ **Do not use accessories that require liquid coolants.** Using water or other liquid coolants may result in electrocution or shock.

Kickback and related warnings

- ▶ Kickback is a sudden reaction to a pinched or snagged rotating wheel, backing pad, brush or any other accessory. Pinching or snagging causes rapid stalling of the rotating accessory which in turn causes the uncontrolled power tool to be forced in the direction opposite of the accessory's rotation at the point of the binding.
For example, if an abrasive wheel is snagged or pinched by the workpiece, the edge of the wheel that is entering into the pinch point can dig into the surface of the material causing the wheel to climb out or kick out. The wheel may either jump toward or away from the operator, depending on direction of the wheel's movement at the point of pinching. Abrasive wheels may also break under these conditions.
Kickback is the result of power tool misuse and/or incorrect operating procedures or conditions and can be avoided by taking proper precautions as given below.
- ▶ **Maintain a firm grip on the power tool and position your body and arm to allow you to resist kickback forces. Always use auxiliary handle, if provided, for maximum control over kickback or torque reaction during start-up.** The operator can control torque reactions or kickback forces, if proper precautions are taken.
- ▶ **Never place your hand near the rotating accessory.** Accessory may kickback over your hand.
- ▶ **Do not position your body in the area where power tool will move if kickback occurs.** Kickback will propel the tool in direction opposite to the wheel's movement at the point of snagging.

4 | English

► **Use special care when working corners, sharp edges, etc. Avoid bouncing and snagging the accessory.** Corners, sharp edges or bouncing have a tendency to snag the rotating accessory and cause loss of control or kickback.

► **Do not attach a saw chain woodcarving blade or too-thick saw blade.** Such blades create frequent kickback and loss of control.

Safety warnings specific for Grinding and Abrasive Cutting-Off operations

► **Use only wheel types that are recommended for your power tool and the specific guard designed for the selected wheel.** Wheels for which the power tool was not designed cannot be adequately guarded and are unsafe.

► **The grinding surface of the centre depressed wheels must be mounted below the plane of the guard lip.** An improperly mounted wheel that projects through the plane of the guard lip cannot be adequately protected.

► **The guard must be securely attached to the power tool and positioned for maximum safety, so the least amount of wheel is exposed towards the operator.** The guard helps to protect operator from broken wheel fragments, accidental contact with wheel and sparks that could ignite clothing.

► **Wheels must be used only for recommended applications. For example: do not grind with the side of the cut-off wheel.** Abrasive cut-off wheels are intended for peripheral grinding; side forces applied to these wheels may cause them to shatter.

► **Always use undamaged wheel flanges that are of correct size and shape for your selected wheel.** Proper wheel flanges support the wheel thus reducing the possibility of wheel breakage. Flanges for cut-off wheels may be different from grinding wheel flanges.

► **Do not use worn down reinforced wheels from larger power tools.** Wheels intended for larger power tools are not suitable for the higher speed of a smaller tool and may burst.

Additional safety warnings specific for abrasive cutting off operations

► **Do not "jam" the cut-off wheel or apply excessive pressure. Do not attempt to make an excessive depth of cut.** Overstressing the wheel increases the loading and susceptibility to twisting or binding of the wheel in the cut and the possibility of kickback or wheel breakage.

► **Do not position your body in line with and behind the rotating wheel.** When the wheel, at the point of operation, is moving away from your body, the possible kickback may propel the spinning wheel and the power tool directly at you.

► **When wheel is binding or when interrupting a cut for any reason, switch off the power tool and hold the power tool motionless until the wheel comes to a complete stop. Never attempt to remove the cut-off wheel from the cut while the wheel is in motion otherwise kickback may occur.** Investigate and take corrective action to eliminate the cause of wheel binding.

► **Do not restart the cutting operation in the workpiece. Let the wheel reach full speed and carefully re-enter the cut.** The wheel may bind, walk up or kickback if the power tool is restarted in the workpiece.

► **Support panels or any oversized workpiece to minimize the risk of wheel pinching and kickback.** Large workpieces tend to sag under their own weight. Supports must be placed under the workpiece near the line of cut and near the edge of the workpiece on both sides of the wheel.

► **Use extra caution when making a "pocket cut" into existing walls or other blind areas.** The protruding wheel may cut gas or water pipes, electrical wiring or objects that can cause kickback.

Safety warnings specific for sanding operations

► **Do not use excessively oversized sanding disc paper. Follow manufacturers recommendations, when selecting sanding paper.** Larger sanding paper extending beyond the sanding pad presents a laceration hazard and may cause snagging, tearing of the disc, or kickback.

Safety warnings specific for wire brushing operations

► **Be aware that wire bristles are thrown by the brush even during ordinary operation. Do not overstress the wires by applying excessive load to the brush.** The wire bristles can easily penetrate light clothing and/or skin.

► **If the use of a guard is recommended for wire brushing, do not allow any interference of the wire wheel or brush with the guard.** Wire wheel or brush may expand in diameter due to work load and centrifugal forces.

Additional safety warnings

Wear safety goggles.



► **Use suitable detectors to determine if utility lines are hidden in the work area or call the local utility company for assistance.** Contact with electric lines can lead to fire and electric shock. Damaging a gas line can lead to explosion. Penetrating a water line causes property damage or may cause an electric shock.

► **Release the On/Off switch and set it to the off position when the power supply is interrupted, e. g., in case of a power failure or when the mains plug is pulled.** This prevents uncontrolled restarting.

► **Do not touch grinding and cutting discs before they have cooled down.** The discs can become very hot while working.

► **Secure the workpiece.** A workpiece clamped with clamping devices or in a vice is held more secure than by hand.

Products sold in GB only: Your product is fitted with a BS 1363/A approved electric plug with internal fuse (ASTA approved to BS 1362).

If the plug is not suitable for your socket outlets, it should be cut off and an appropriate plug fitted in its place by an authorised customer service agent. The replacement plug should have the same fuse rating as the original plug.

The severed plug must be disposed of to avoid a possible shock hazard and should never be inserted into a mains socket elsewhere.

Products sold in AUS and NZ only: Use a residual current device (RCD) with a rated residual current of 30 mA or less.

Product Description and Specifications



Read all safety warnings and all instructions. Failure to follow the warnings and instructions may result in electric shock, fire and/or serious injury.

Intended Use

The machine is intended for cutting, roughing and brushing of metal and stone materials without the use of water.

For cutting with bonded abrasives, a special cutting guard (accessory) must be used.

When cutting in stone, provide for sufficient dust extraction.

With approved sanding tools, the machine can be used for sanding with sanding discs.

Product Features

The numbering of the product features refers to the illustration of the machine on the graphics page.

- 1 Spindle lock button
- 2 On/Off switch
- 3 Auxiliary handle (insulated gripping surface)*
- 4 Grinder spindle
- 5 Locking screw for protection guard
- 6 Protection guard for grinding
- 7 Mounting flange
- 8 Grinding wheel*
- 9 Clamping nut
- 10 Carbide grinding head*
- 11 Protection guard for cutting*
- 12 Cutting disc*
- 13 Hand guard*
- 14 Rubber sanding plate*
- 15 Sanding sheet*
- 16 Round nut*
- 17 Cup brush*
- 18 Cutting guide with dust extraction protection guard*
- 19 Diamond cutting disc*
- 20 Handle (insulated gripping surface)

*Accessories shown or described are not part of the standard delivery scope of the product. A complete overview of accessories can be found in our accessories program.

Technical Data

Angle Grinder	GWS 660	
Article number		3 601 C75 6..
Rated power input	W	660
Rated speed	min-1	11 000
Grinding disc diameter, max.	mm	100
Thread of grinder spindle		M 10
Thread length (max.) of grinder spindle	mm	17
Weight according to EPTA-Procedure 01:2014	kg	1.6
Net weight*	kg	1.5
Protection class		□/II

* measured without protection guard and auxiliary handle

The values given are valid for a nominal voltage [U] of 230 V. For different voltages and models for specific countries, these values can vary.

Assembly

Mounting the Protective Devices

- **Before any work on the machine itself, pull the mains plug.**

Note: After breakage of the grinding disc during operation or damage to the holding fixtures on the protection guard/power tool, the machine must promptly be sent to an after-sales service agent for maintenance. For addresses, see section After-sales Service and Application Service.

Protection Guard for Grinding

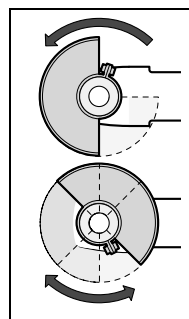

Place the protection guard **6** on the spindle collar. Adjust the position of the protection guard **6** to the requirements of the operation. Lock the protection guard **6** by tightening the locking screw **5** using a Phillips screwdriver.

- **Adjust the protection guard **6** in such a manner that sparking is prevented in the direction of the operator.**

Note: The encoding keys on the protection guard **6** ensure that only a protection guard that fits the machine type can be mounted.

Protection Guard for Cutting

- **For cutting with bonded abrasives, always use the protection guard for cutting **11**.**
- **Provide for sufficient dust extraction when cutting stone.**

The protection guard for cutting **11** is mounted in the same manner as the protection guard for grinding **6**.

6 | English

Cutting Guide with Dust Extraction Protection Guard

The cutting guide with dust extraction protection guard **18** is mounted in the same manner as the protection guard for grinding **6**.

Auxiliary Handle

Screw the auxiliary handle **3** on the right or left of the machine head depending on the working method.

Hand Guard

► **For operations with the rubber sanding plate 14 or with the cup brush/wheel brush/flap disc, always mount the hand guard 13.**

The hand guard **13** is fastened with the auxiliary handle **3**.

Mounting the Grinding Tools

► **Before any work on the machine itself, pull the mains plug.**

► **Do not touch grinding and cutting discs before they have cooled down.** The discs can become very hot while working.

Clean the grinder spindle **4** and all parts to be mounted.

For clamping and loosening the grinding tools, lock the grinder spindle with the spindle lock button **1**.

► **Actuate the spindle lock button only when the grinder spindle is at a standstill.** Otherwise, the machine may become damaged.

Grinding/Cutting Disc

Pay attention to the dimensions of the grinding tools. The mounting hole diameter must fit the mounting flange without play. Do not use reducers or adapters.

When using diamond cutting discs, pay attention that the direction-of-rotation arrow on the diamond cutting disc and the direction of rotation of the machine (see direction-of-rotation arrow on the machine head) agree.

See graphics page for the mounting sequence.

To fasten the grinding/cutting disc, screw on the clamping nut **9** and tighten with the two-hole spanner.

► **After mounting the grinding tool and before switching on, check that the grinding tool is correctly mounted and that it can turn freely. Make sure that the grinding tool does not graze against the protection guard or other parts.**

Mounting flange for grinding spindle M 10: The mounting flange can be used on both sides.

Flap Disc

► **For operations with the flap disc, always mount the hand guard 13.**

Rubber Sanding Plate

► **For operations with the rubber sanding plate 14, always mount the hand guard 13.**

See graphics page for the mounting sequence.

Screw on the round nut **16** and tighten with the two-pin spanner.

Cup Brush/Disc Brush

► **For operations with the cup brush/wheel brush, always mount the hand guard 13.**

See graphics page for the mounting sequence.



The cup brush/disc brush must be able to be screwed onto the grinder spindle until it rests firmly against the grinder spindle flange at the end of the grinder spindle threads. Tighten the cup brush/disc brush with an open-end spanner.

Approved Grinding Tools

All grinding tools mentioned in these operating instructions can be used.

The permissible speed [min^{-1}] or the circumferential speed [m/s] of the grinding tools used must at least match the values given in the table.

Therefore, observe the permissible **rotational/circumferential speed** on the label of the grinding tool.

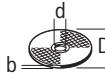
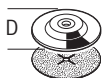
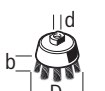
	max. [mm]		[mm]	 [min^{-1}]	 [m/s]
	D	b	d		
	100	6	16.0	11000	80
	100	-	-	11000	80
	70	30	M 10	11000	45

Rotating the Machine Head

► **Before any work on the machine itself, pull the mains plug.**

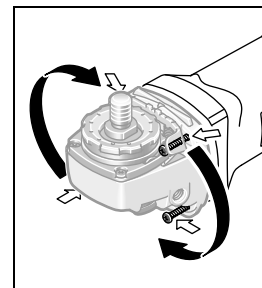

The machine head can be rotated with respect to the machine housing in 90° steps. In this manner, the On/Off switch can be brought into a more convenient position for special working situations, e.g. for left-handed persons.

Completely unscrew the four screws. Rotate the machine head carefully,

without removing it from the housing, to the new position. Screw in and tighten the four screws again.

Dust/Chip Extraction

- ▶ Dusts from materials such as lead-containing coatings, some wood types, minerals and metal can be harmful to one's health. Touching or breathing-in the dusts can cause allergic reactions and/or lead to respiratory infections of the user or bystanders. Certain dusts, such as oak or beech dust, are considered as carcinogenic, especially in connection with wood-treatment additives (chromate, wood preservative). Materials containing asbestos may only be worked by specialists.
 - As far as possible, use a dust extraction system suitable for the material.
 - Provide for good ventilation of the working place.
 - It is recommended to wear a P2 filter-class respirator.

Observe the relevant regulations in your country for the materials to be worked.

- ▶ **Prevent dust accumulation at the workplace.** Dusts can easily ignite.

Operation

Starting Operation

- ▶ **Observe correct mains voltage! The voltage of the power source must agree with the voltage specified on the nameplate of the machine. Power tools marked with 230 V can also be operated with 220 V.**
- ▶ **Hold power tool by insulated gripping surfaces 20 and auxiliary handle 3 only. The accessory may contact hidden wiring or its own cord.** Accessory contacting a "live" wire may make exposed metal parts of the power tool "live" and shock the operator.

When operating the machine with power from mobile generators that do not have sufficient reserve capacity or are not equipped with suitable voltage control with starting current amplification, loss of performance or untypical behavior can occur upon switching on.

Please observe the suitability of the power generator being used, particularly with regard to the mains voltage and frequency.

Switching On and Off

To save energy, only switch the power tool on when using it.

To **start** the power tool, push the On/Off switch **2** forwards.

To **lock** the On/Off switch **2**, press the On/Off switch **2** down at the front until it latches.

To **switch off** the power tool, release the On/Off switch **2** or, if it is locked, briefly push down the back of the On/Off switch **2** and then release it.

- ▶ **Check grinding tools before using. The grinding tool must be mounted properly and be able to move freely. Carry out a test run for at least one minute with no load. Do not use damaged, out-of-centre or vibrating grinding tools.** Damaged grinding tools can burst and cause injuries.

Working Advice

- ▶ **Exercise caution when cutting slots in structural walls; see Section "Information on Structures".**
- ▶ **Clamp the workpiece if it does not remain stationary due to its own weight.**
- ▶ **Do not strain the machine so heavily that it comes to a standstill.**
- ▶ **After heavily straining the power tool, continue to run it at no-load for several minutes to cool down the accessory.**
- ▶ **Do not touch grinding and cutting discs before they have cooled down.** The discs can become very hot while working.
- ▶ **Do not use the power tool with a cut-off stand.**
- ▶ **Hold power tool by insulated gripping surfaces 20 and auxiliary handle 3 only. The accessory may contact hidden wiring or its own cord.** Accessory contacting a "live" wire may make exposed metal parts of the power tool "live" and shock the operator.

Rough Grinding

- ▶ **Never use a cutting disc for roughing.**

The best roughing results are achieved when setting the machine at an angle of 30° to 40°. Move the machine back and forth with moderate pressure. In this manner, the workpiece will not become too hot, does not discolour and no grooves are formed.

Flap Disc

With the flap disc (accessory), curved surfaces and profiles can be worked.

Flap discs have a considerably higher service life, lower noise levels and lower sanding temperatures than conventional sanding sheets.

Cutting Metal

- ▶ **For cutting with bonded abrasives, always use the protection guard for cutting 11.**

When cutting, work with moderate feed, adapted to the material being cut. Do not exert pressure onto the cutting disc, tilt or oscillate the machine.

Do not reduce the speed of running down cutting discs by applying sideward pressure.

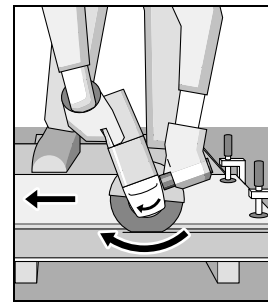

The machine must always work in an up-grinding motion. Otherwise, the danger exists of it being pushed **uncontrolled** out of the cut.

When cutting profiles and square bar, it is best to start at the smallest cross section.

8 | English

Cutting Stone

- ▶ **Provide for sufficient dust extraction when cutting stone.**
- ▶ **Wear a dust respirator.**
- ▶ **The machine may be used only for dry cutting/grinding.**

For cutting stone, it is best to use a diamond cutting disc.

When using the cutting guide with dust extraction protection guard **18**, the vacuum cleaner must be approved for vacuuming masonry dust. Suitable vacuum cleaners are available from Bosch.

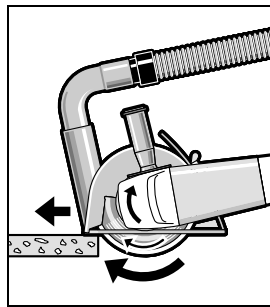

Switch on the machine and place the front part of the cutting guide on the workpiece. Slide the machine with moderate feed, adapted to the material to be worked.

For cutting especially hard material, e. g., concrete with high pebble content, the diamond cutting disc can over-heat and become damaged as a result. This is clearly indicated by circular sparking, rotating with the diamond cutting disc.

In this case, interrupt the cutting process and allow the diamond cutting disc to cool by running the machine for a short time at maximum speed with no load.

Noticeably decreasing work progress and circular sparking are indications of a diamond cutting disc that has become dull. Briefly cutting into abrasive material (e. g. lime-sand brick) can resharpen the disc again.

Information on Structures

Slots in structural walls are subject to the Standard DIN 1053 Part 1, or country-specific regulations.

These regulations are to be observed under all circumstances. Before beginning work, consult the responsible structural engineer, architect or the construction supervisor.

Maintenance and Service**Maintenance and Cleaning**

- ▶ **Before any work on the machine itself, pull the mains plug.**
- ▶ **For safe and proper working, always keep the machine and ventilation slots clean.**
- ▶ **In extreme conditions, always use dust extraction as far as possible. Blow out ventilation slots frequently and install a portable residual current device (PRCD).**

When working metals, conductive dust can settle in the interior of the power tool. The total insulation of the power tool can be impaired.

Please store and handle the accessory(-ies) carefully.

If the replacement of the supply cord is necessary, this has to be done by Bosch or an authorized Bosch service agent in order to avoid a safety hazard.

After-sales Service and Application Service

Our after-sales service responds to your questions concerning maintenance and repair of your product as well as spare parts. Exploded views and information on spare parts can also be found under:

www.bosch-pt.com

Bosch's application service team will gladly answer questions concerning our products and their accessories.

In all correspondence and spare parts order, please always include the 10-digit article number given on the type plate of the machine.

People's Republic of China**China Mainland**

Bosch Power Tools (China) Co., Ltd.
567, Bin Kang Road
Bin Jiang District 310052
Hangzhou, P. R. China
Service Hotline: 4008268484
Fax: (0571) 87774502
E-Mail: contact.ptcn@cn.bosch.com
www.bosch-pt.com.cn

HK and Macau Special Administrative Regions

Robert Bosch Hong Kong Co. Ltd.
21st Floor, 625 King's Road
North Point, Hong Kong
Customer Service Hotline: +852 2101 0235
Fax: +852 2590 9762
E-Mail: info@hk.bosch.com
www.bosch-pt.com.hk

Indonesia

PT Robert Bosch
Palma Tower 9th & 10th Floor
Jl. Let. Jend. TB Simatupang II S/06
Jakarta Selatan 12960
Indonesia
Tel.: (021) 3005 6565
Fax: (021) 3005 5801
E-Mail: boschpowertools@id.bosch.com
www.bosch-pt.co.id

Philippines

Robert Bosch, Inc.
28th Floor Fort Legend Towers,
3rd Avenue corner 31st Street,
Fort Bonifacio Global City,
1634 Taguig City, Philippines
Tel.: (02) 8703871
Fax: (02) 8703870
matheus.contiero@ph.bosch.com
www.bosch-pt.com.ph

Bosch Service Center:
9725-27 Kamagong Street
San Antonio Village
Makati City, Philippines
Tel.: (02) 8999091
Fax: (02) 8976432
rosalie.dagdagan@ph.bosch.com

Malaysia

Robert Bosch (S.E.A.) Sdn. Bhd.
No. 8A, Jalan 13/6
G.P.O. Box 10818
46200 Petaling Jaya
Selangor, Malaysia
Tel.: (03) 79663194
Fax: (03) 79583838
cheehoe.on@my.bosch.com
Toll-Free: 1800 880188
www.bosch-pt.com.my

Thailand

Robert Bosch Ltd.
Liberty Square Building
No. 287, 11 Floor
Silom Road, Bangrak
Bangkok 10500
Tel.: 02 6393111, 02 6393118
Fax: 02 2384783
Robert Bosch Ltd., P. O. Box 2054
Bangkok 10501, Thailand
www.bosch.co.th

Bosch Service – Training Centre
La Salle Tower Ground Floor Unit No.2
10/11 La Salle Moo 16
Srinakharin Road
Bangkaew, Bang Plee
Samutprakarn 10540
Thailand
Tel.: 02 7587555
Fax: 02 7587525

Singapore

Robert Bosch (SEA) Pte. Ltd.
11 Bishan Street 21
Singapore 573943
Tel.: 6571 2772
Fax: 6350 5315
leongheng.leow@sg.bosch.com
Toll-Free: 1800 3338333
www.bosch-pt.com.sg

Vietnam

Robert Bosch Vietnam Co. Ltd
10/F, 194 Golden Building
473 Dien Bien Phu Street
Ward 25, Binh Thanh District
84 Ho Chi Minh City
Vietnam
Tel.: (08) 6258 3690 ext. 413
Fax: (08) 6258 3692
hieu.lagia@vn.bosch.com
www.bosch-pt.com

Australia, New Zealand and Pacific Islands

Robert Bosch Australia Pty. Ltd.
Power Tools
Locked Bag 66
Clayton South VIC 3169
Customer Contact Center
Inside Australia:
Phone: (01300) 307044
Fax: (01300) 307045
Inside New Zealand:
Phone: (0800) 543353
Fax: (0800) 428570
Outside AU and NZ:
Phone: +61 3 95415555
www.bosch.com.au

Disposal

The machine, accessories and packaging should be sorted for environmental-friendly recycling.
Do not dispose of power tools into household waste!

Subject to change without notice.